

Karin Guttman

MATEMATIK

häfte

1

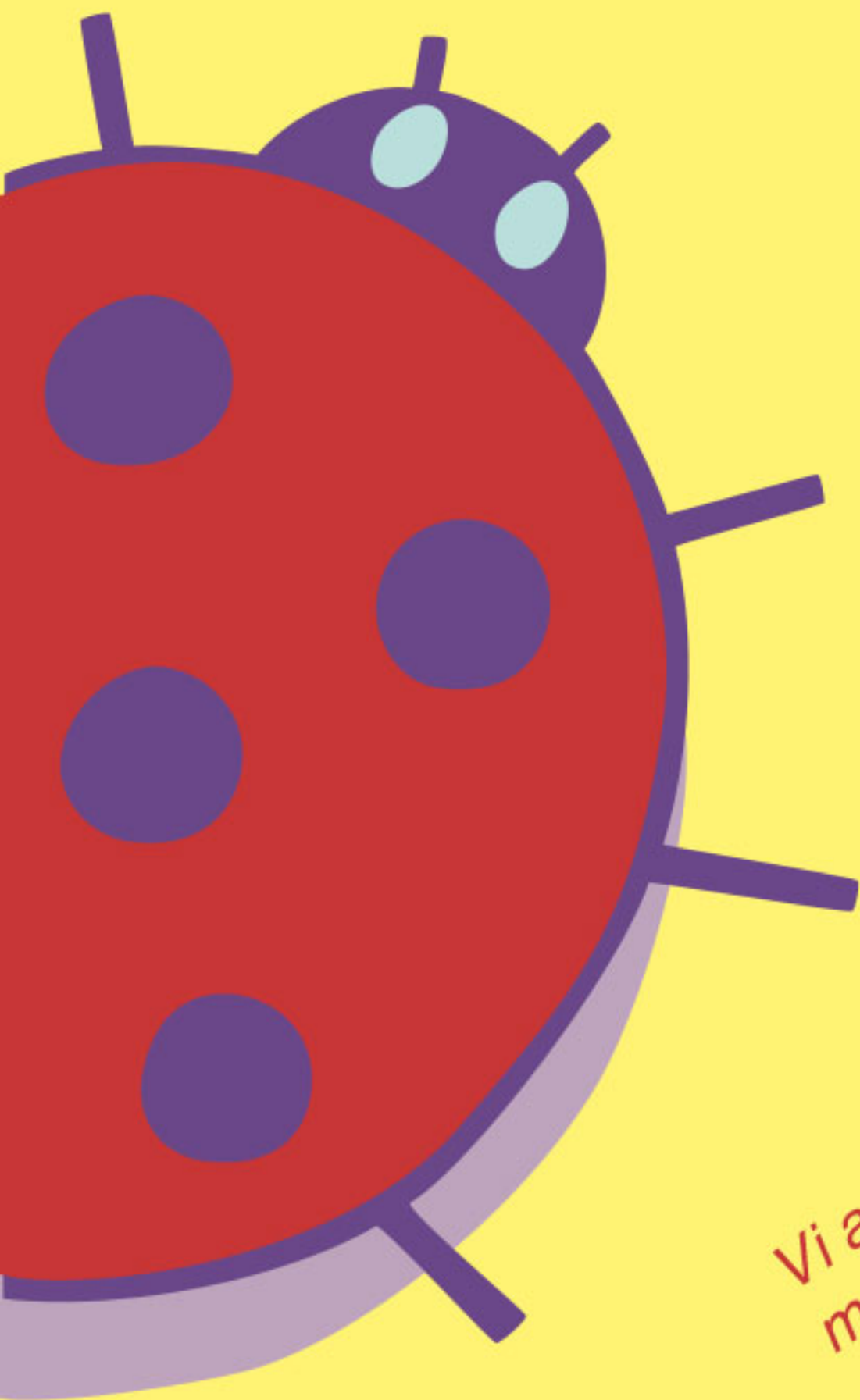

Vi arbetar med tal
mellan 0 och 6



1

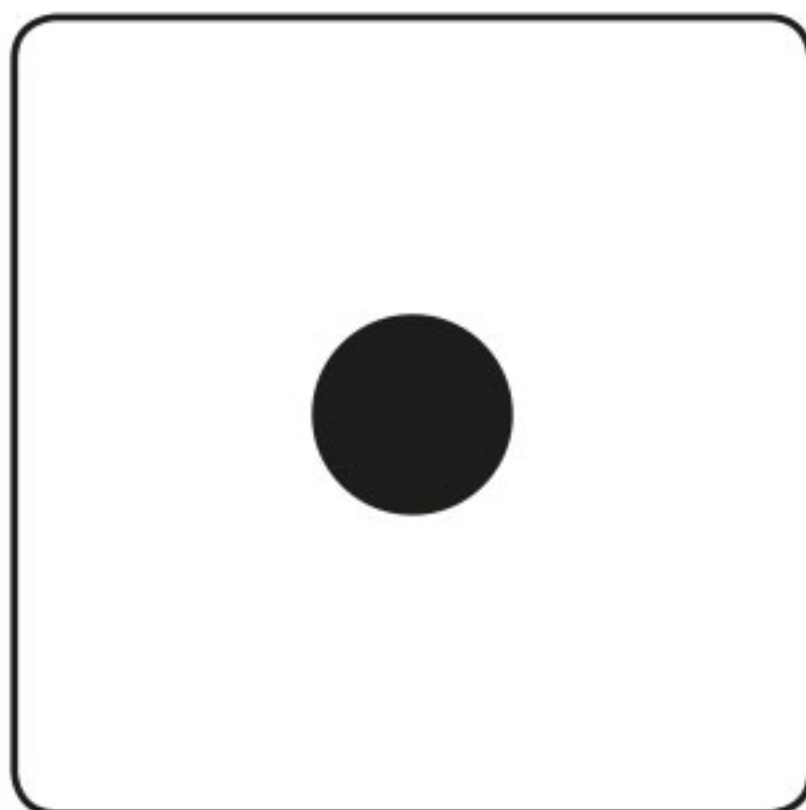

Känn igen talet 1. Dra ett streck från tämningen till bilden med 1 kanin.

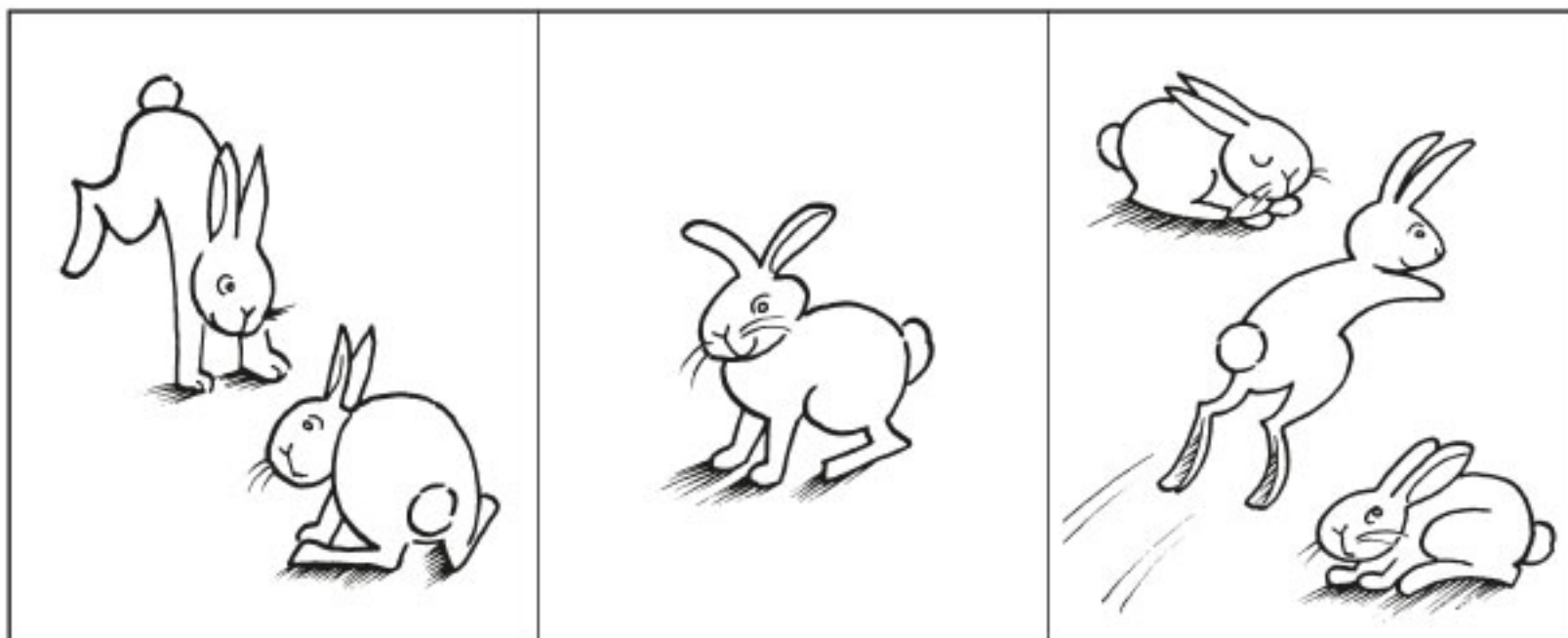

3

Rita lika många streck som det finns saker på varje rad. Den som kan skriva siffror. Var är det inte 3?
Leta efter 3 saker på husen. För den som kan: 1 pojke och 2 flickor är 3, ett öppet och 2 stängda lås är 3 osv. Ordningstal

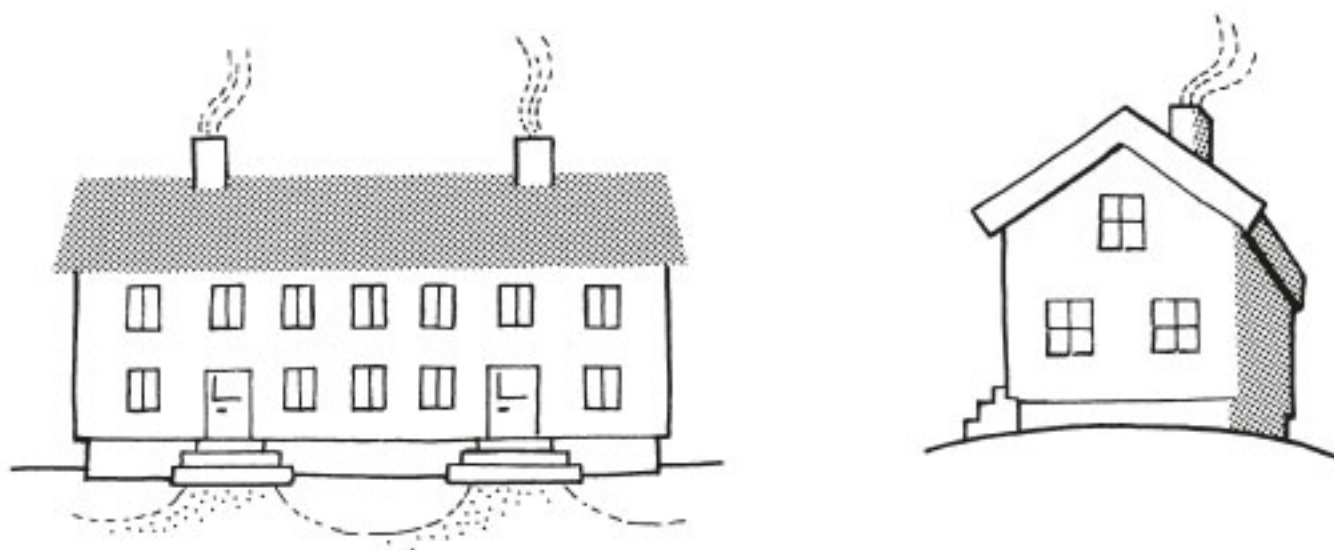
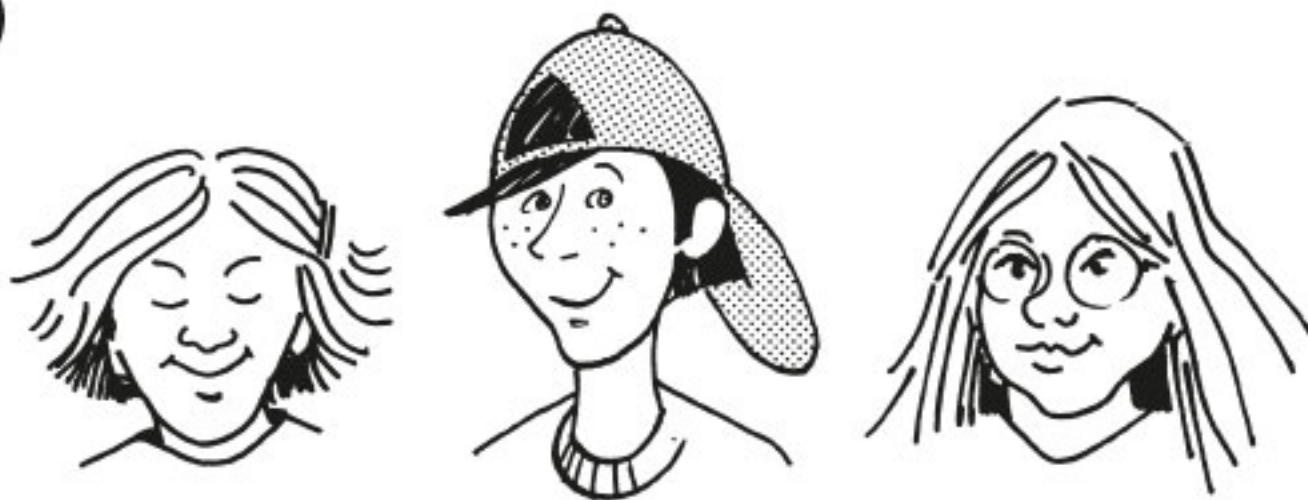

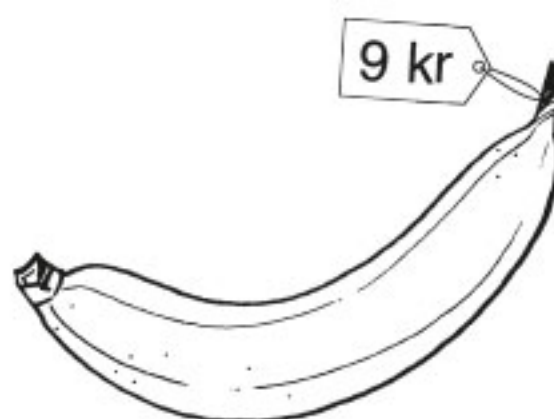
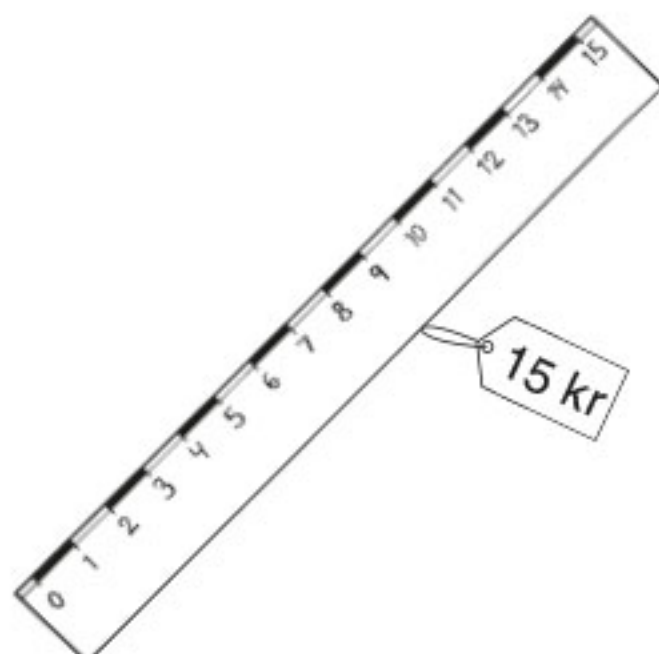
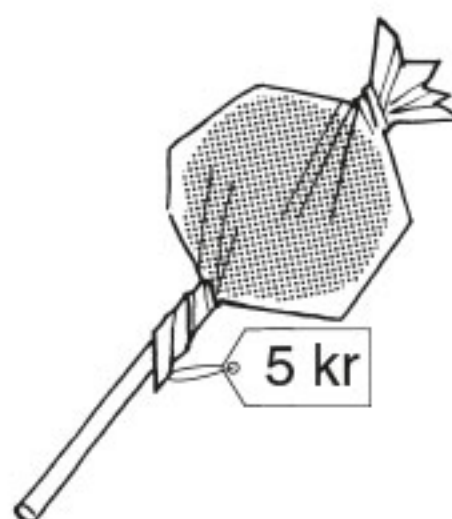
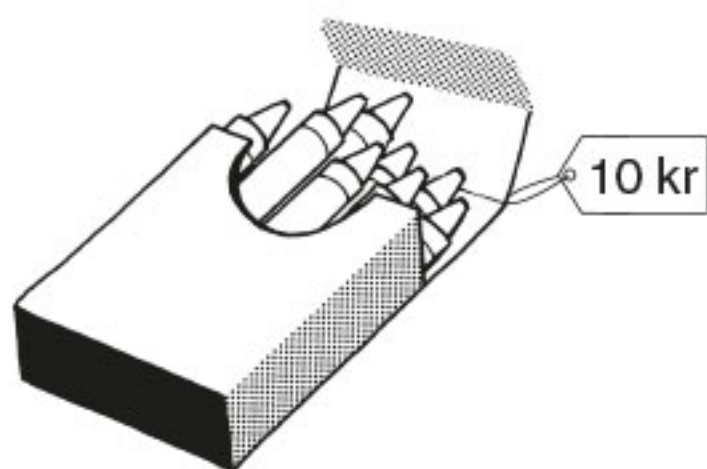
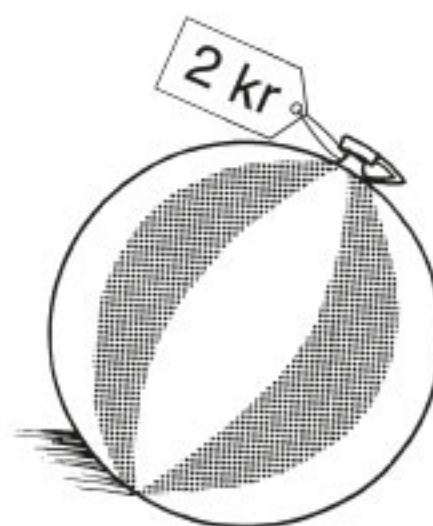
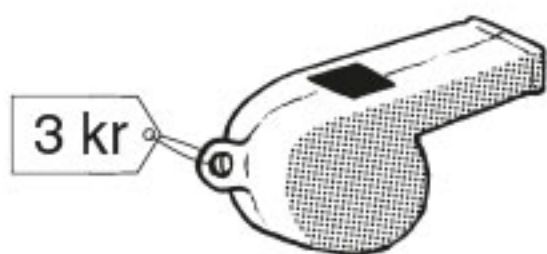

Köp för högst 5 kronor. Vad kan du köpa?

1 **2** **3** **4** **5** **6**













Vad visar tärningen? Sätt ut rätt siffror.

	1	+	1	=				
	1	+	2	=				
	1	+	3	=				
	1	+	4	=				

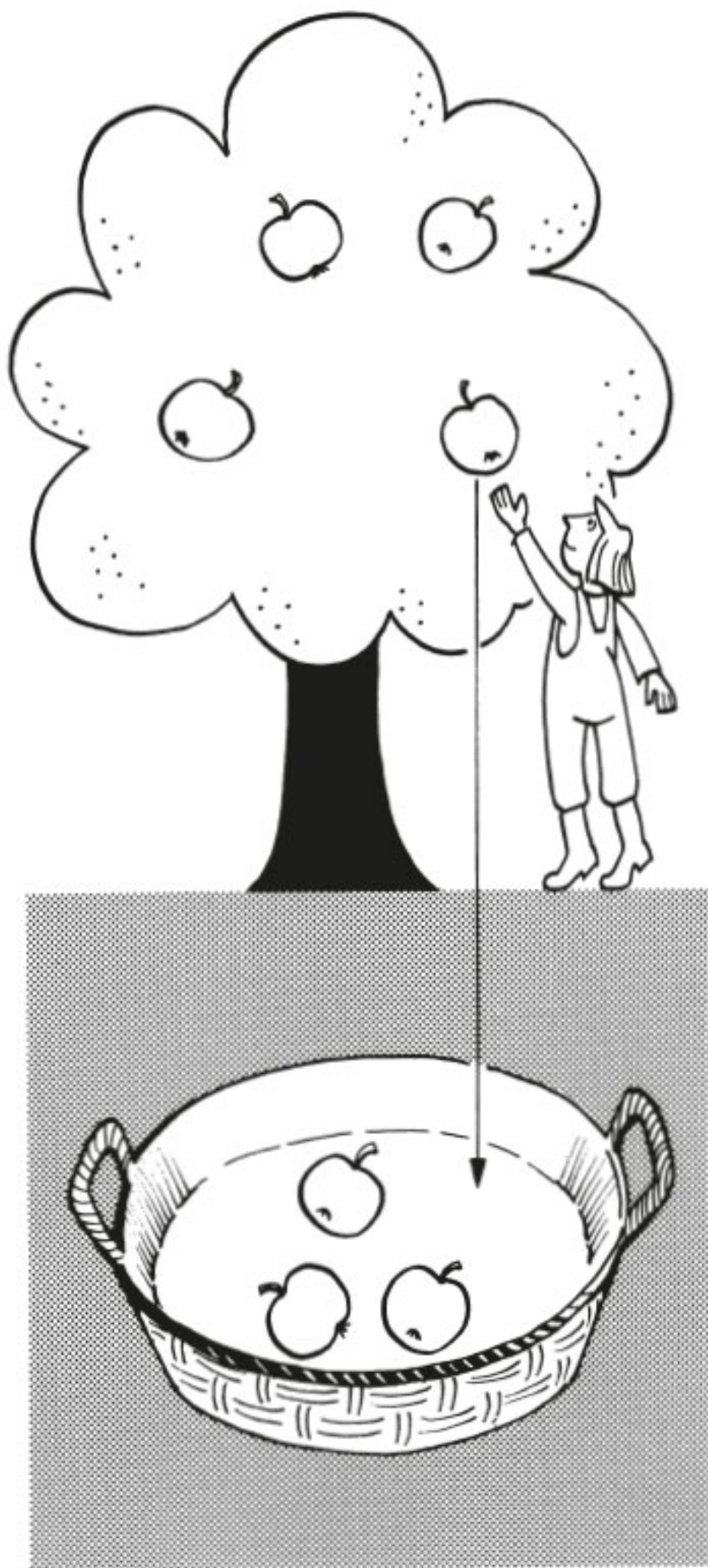

$$4 - 1 = \underline{\quad}$$

$$\underline{\quad} - 1 = 3$$

$$4 - \underline{\quad} = 3$$

$$1 + 3 = \underline{\quad}$$

$$3 + 1 = \underline{\quad}$$

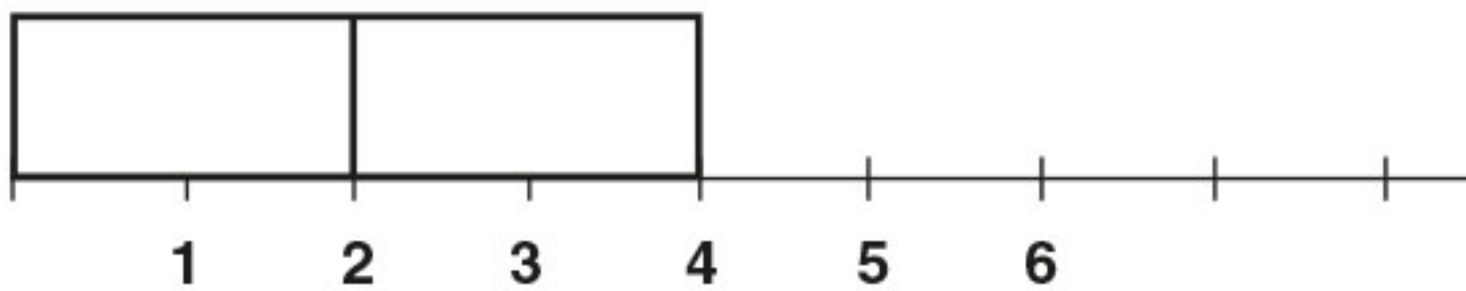

$$4 - 2 = \underline{\quad}$$

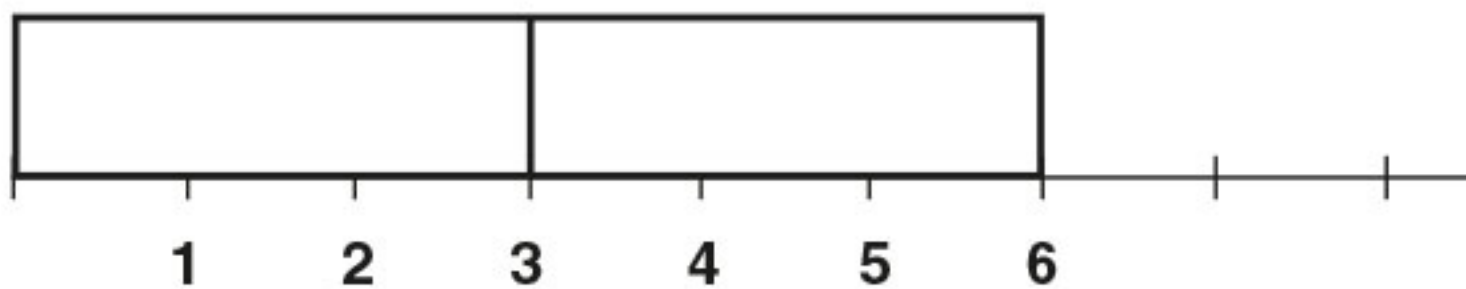

$$6 - 3 = \underline{\quad}$$

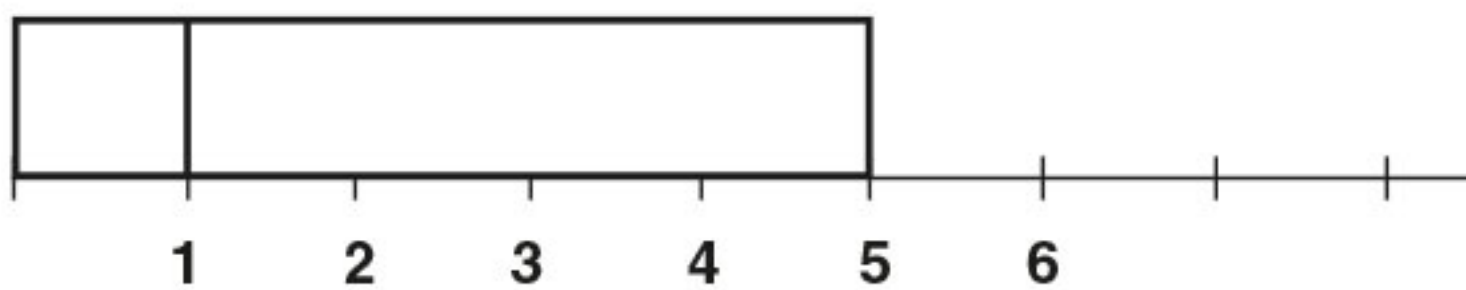

$$5 - 4 = \underline{\quad}$$

Lägg och skriv.