













ROLIG RÄKNING 4

LENA HEDLUND

Skriv hur många tior och enkronor som finns på varje rad.

	Tior	Enkronor
		
		
		
		
		
		
		
		
		
		

Skriv talen från 1–40.

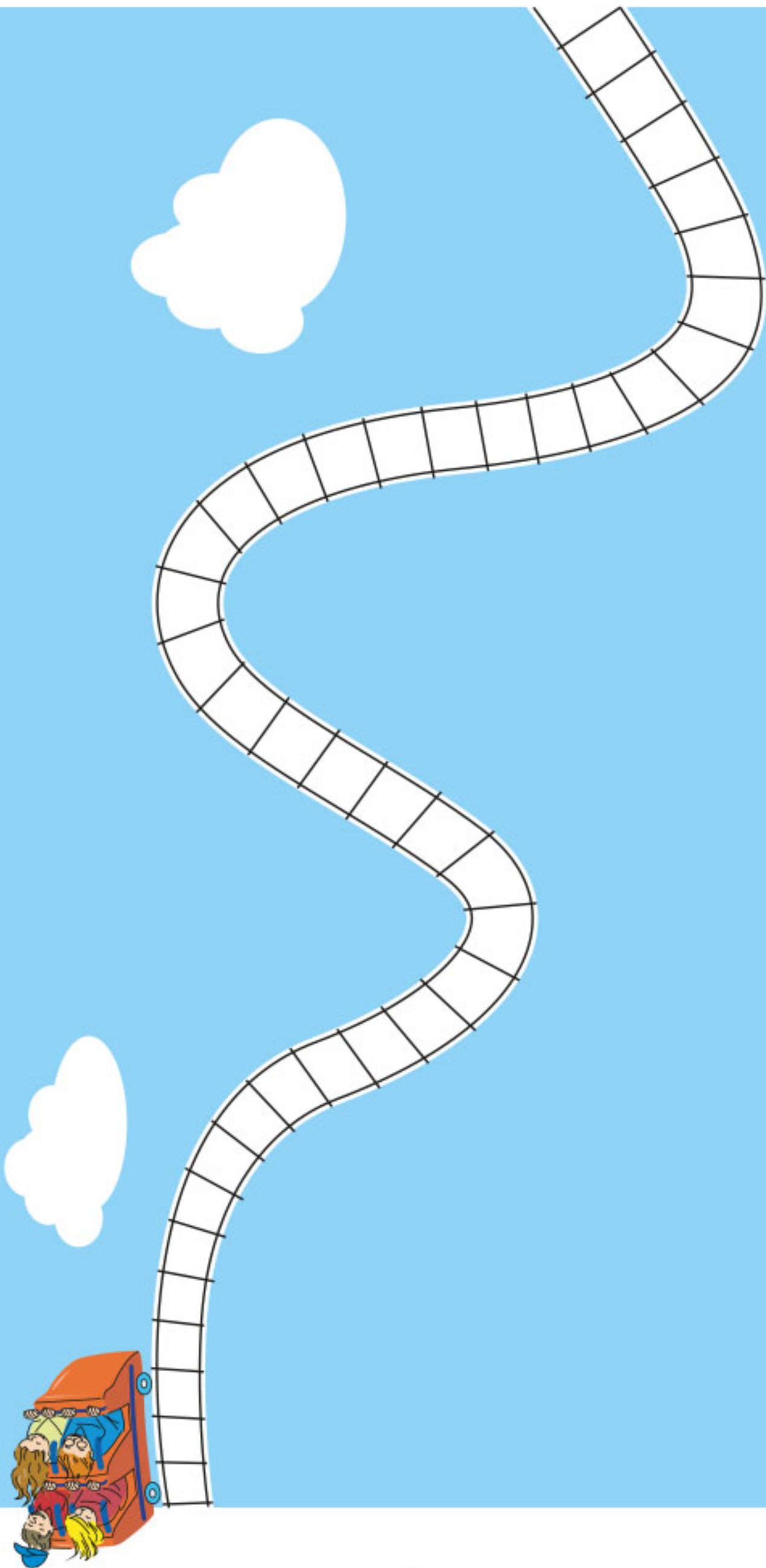



_____ kronor

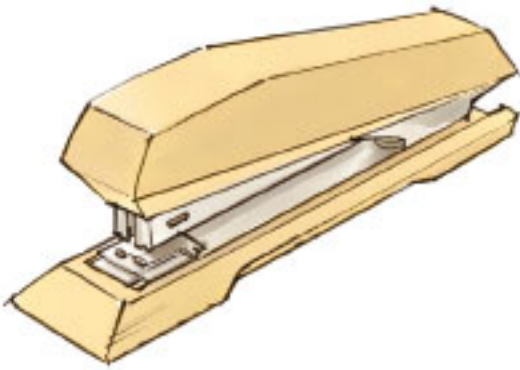

_____ kronor



_____ kronor

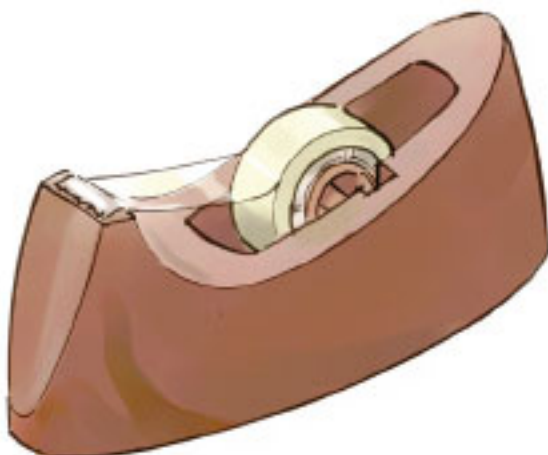

_____ kronor

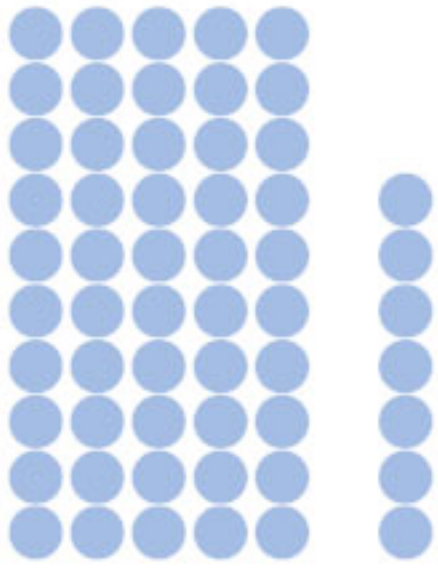

$$\underline{\hspace{2cm}} + \underline{\hspace{1cm}} = \underline{\hspace{2cm}}$$

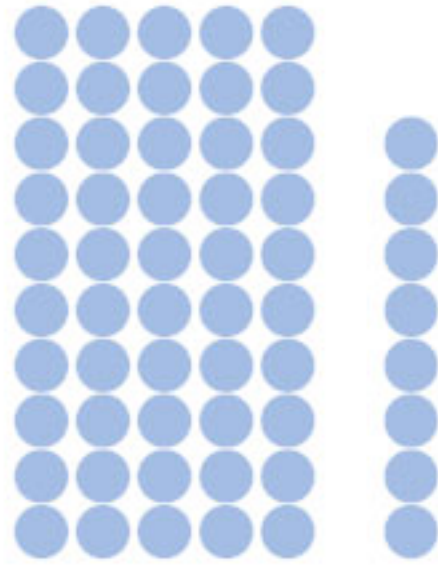

$$\underline{\hspace{2cm}} + \underline{\hspace{1cm}} = \underline{\hspace{2cm}}$$

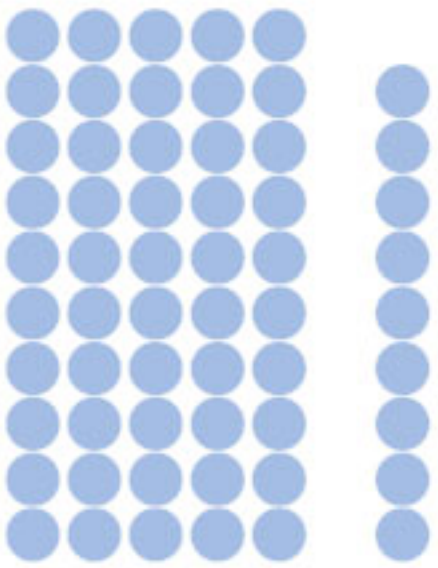

$$\underline{\hspace{2cm}} + \underline{\hspace{1cm}} = \underline{\hspace{2cm}}$$

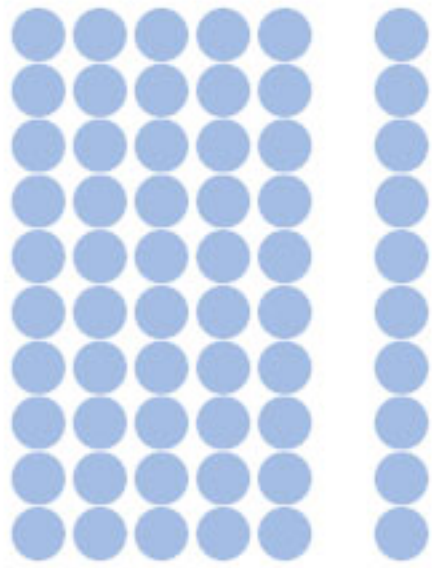

$$\underline{\hspace{2cm}} + \underline{\hspace{1cm}} = \underline{\hspace{2cm}}$$

$$50 + 1 = \underline{\hspace{2cm}}$$

$$50 + 10 = \underline{\hspace{2cm}}$$

$$50 + 3 = \underline{\hspace{2cm}}$$

$$50 + 2 = \underline{\hspace{2cm}}$$

$$50 + 5 = \underline{\hspace{2cm}}$$

$$50 + 4 = \underline{\hspace{2cm}}$$

$$50 + 7 = \underline{\hspace{2cm}}$$

$$50 + 6 = \underline{\hspace{2cm}}$$

$$50 + 9 = \underline{\hspace{2cm}}$$

$$50 + 8 = \underline{\hspace{2cm}}$$

Hur mycket är klockan?

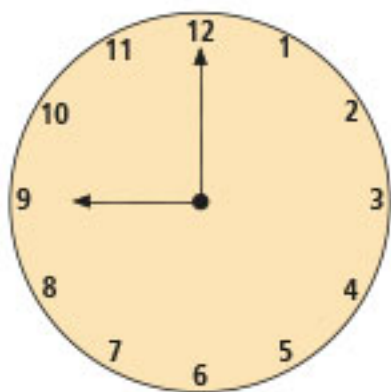

9.00

21.00

nio

